

版本 REV.	日期 DATE	ECN NO.	变更内容 DESCRIPTION	制图 DRAWN

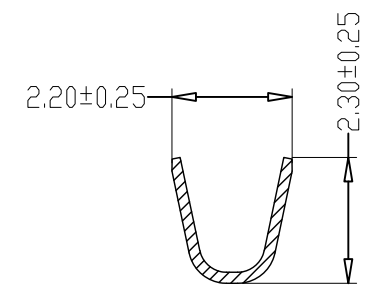

SEC: A-A

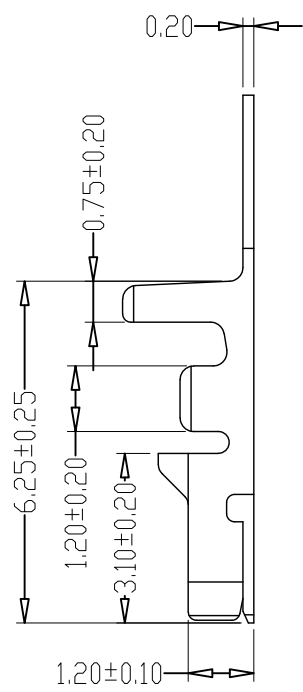
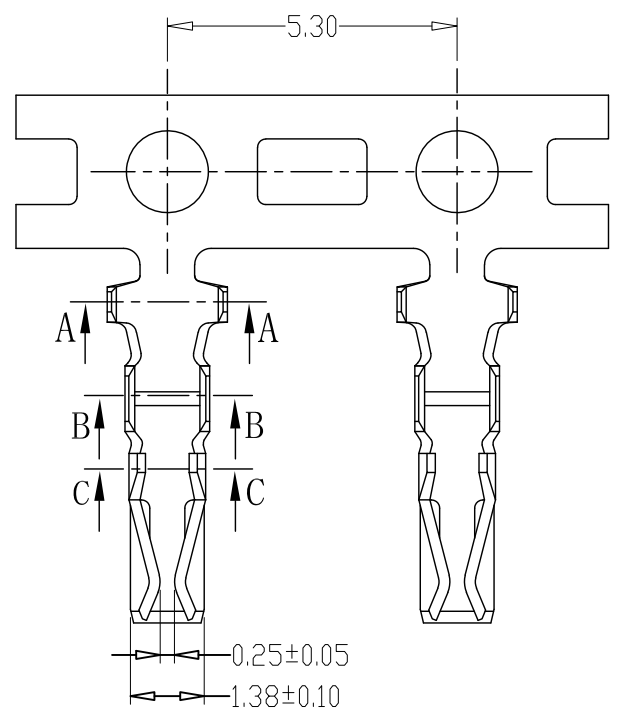
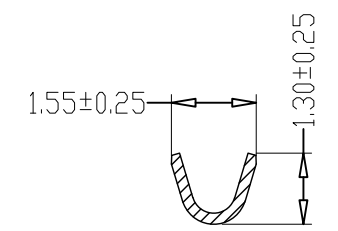

SEC: B-B

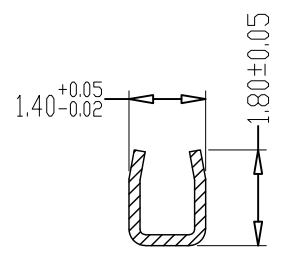

SEC: C-C

SPECIFICATIONS

- 1、Current Rating: 2A AC, DC
- 2、Voltage Rating: 50V AC, DC
- 3、Temperatuer Range: -25°C ~+85°C
- 4、Contact Resistance: 20mΩ Max
- 5、Insulation Resistance: 1000MΩ Min
- 6、Withstanding Voltang: 800V AC/minute
- 7、Material: Phosphoric bronze Tin-plated
- 8、Applicable Wire Sizes: AWG#22~30#

GENERAL TOLERANCE		制图 Mapping	姚 勇 2024、09、10	料号 PART NO.	D0020-T	版本 REV.	A
X.±0.25	X.*±2'	审核 Audit	钱岳生 2024、09、10	品名 TITLE	DPS-5P端子	页次 SHEET	1/1
.X±0.20	.X*±1'	核准 Approved	张 名 2024、09、11	客户料号 CUTM. NO.		 乐清市宏一电子有限公司 YueQing HongYi Electronics Co., Ltd	
.XX±0.15	.XX*±0.5'	单位 Units	MM	比例 SCALE	1:1		
.XXX±0.10	.XXX*±0.5'						

版本 REV.	日期 DATE	ECN NO.	变更内容 DESCRIPTION	制图 DRAWN

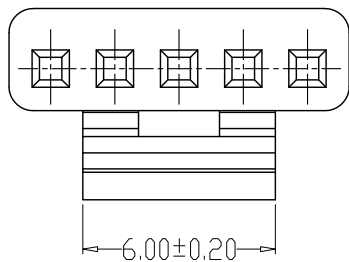
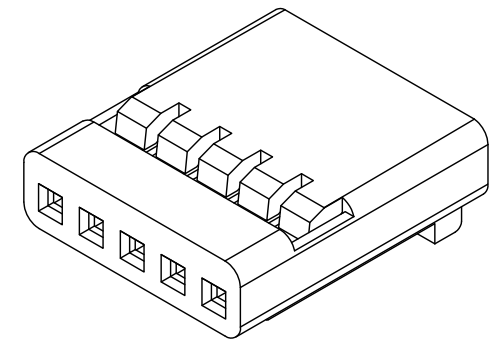
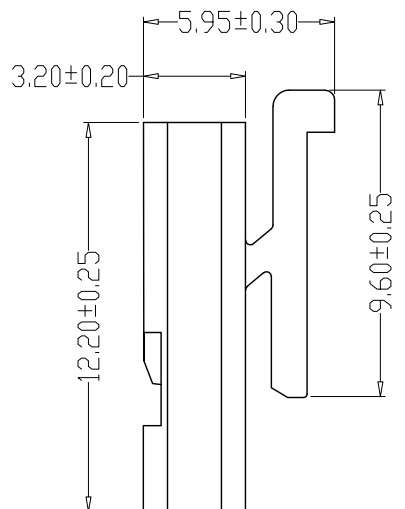
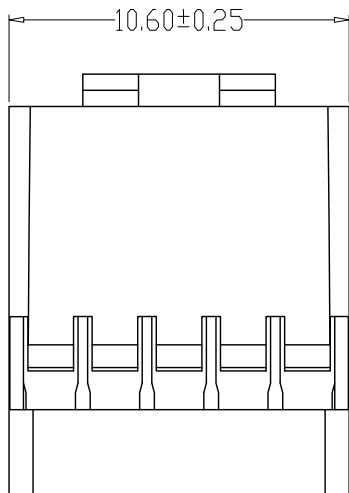
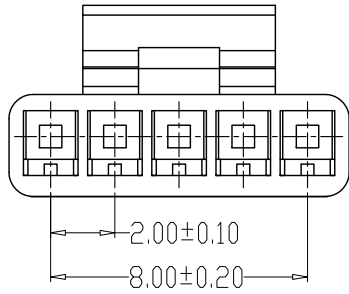

SPECIFICATIONS

- 1、Current Rating: 2A AC, DC
- 2、Voltage Rating: 50V AC, DC
- 3、Temperatuer Range: -25°C~+85°C
- 4、Contact Resistance: 20mΩ Max
- 5、Insulation Resistance: 1000MΩ Min
- 6、Withstanding Voltang: 800V AC/minute
- 7、Material: PA66, UL94V-2

GENERAL TOLERANCE		制图 Mapping	姚 勇 2024、09、10	料号 PART NO.	D0020-5P	版本 REV.	A
X.±0.25	X.*±2'	审核 Audit	钱岳生 2024、09、10	品名 TITLE	DPS-5P孔座	页次 SHEET	1/1
.X±0.20	.X*±1'	核准 Approved	张 名 2024、09、11	客户料号 CUTM. NO.			
.XX±0.15	.XX*±0.5'	单位 Units	MM	比例 SCALE	1:1		
.XXX±0.10	.XXX*±0.5'			<b>乐清市宏一电子有限公司</b> YueQing HongYi Electronics Co., Ltd			